



China patent No.:
ZL02220153.X,
ZL200720045551.5

Multi-functional Flow Control Valve for Water Treatment Systems

63540 (Old Model No.: F78A1)

63640 (Old Model No.: F78A3)

53530 (Old Model No.: F78B1)

Instruction Manual





Please read this manual in details
before using this valve and keep it properly
in order to consult in the future

0WRX.466.512

MODEL: 63540-F78A1/63640-F78A3/53530-F78B1

Before the valve put into use, please fill in the below content so as to help us to refer in the future.

The Program Type Setting (Operation by professional)

When all symbols light on, press and hold  and  buttons for 5 seconds to enter the menu of valve model selection. Please set the program type in accordance with the product type. (Time clock type by days or hours or Meter type); for example, F78A should be set to F78A1, F78A2 or F78A3, F78B should be set to F78B1 or F78B2. You couldn't set to other type.

Softener System Configuration

Tank Size: Dia. _____ mm, Height _____ mm;
Resin Volume _____ L; Brine Tank Capacity _____ L;
Hardness of Raw Water _____ mmol/L;
Pressure of Inlet Water _____ MPa;
Control Valve Model _____ ; Number _____ ;
The Specification of Drain Line Flow Control _____ ;
Injector No. _____ .
Water Source: Ground-water Filtered Ground-water
Tap Water Other _____ .

Parameter Set

Parameter	Unit	Factory Default	Actual Value
Water Treatment Capacity (Meter type)	m ³	400	
Control Mode A-01(02)	/	A-01	
Service Days (Time clock type, by days)	D.	03	
Service Hours (Time clock type, by hours)	H.	20	
Regeneration Time	/	02:00	
Backwash Time	min.	10	
Brine & Slow Rinse Time	min.	60	
Fast Rinse Time	min.	10	
Brine Refill Time	min.	05	
Interval Regeneration Days	D.	30	
Output Mode b-01 (02)	/	b-01	

● If there is no special requirement when product purchase, we choose 3# drain line flow control and 3# injector for the standard configuration.

Catalogue

Notice.....	3
1.Product Overview.....	4
1.1.Main Application & Applicability.....	4
1.2.Product Characteristics.....	4
1.3.Service Condition.....	7
1.4.Product Structure and Technical Parameters.....	8
1.5. Installation.....	9
2.Basic Setting & Usage.....	18
2.1.The Function of PC Board.....	18
2.2.Basic Setting & Usage.....	20
3.Applications.....	23
3.1.Softener Flow Chart.....	23
3.2.The Function and Connection of PC Board.....	26
A. Signal Output Connector.....	27
B. Interlock.....	30
C. Remote Handling Connector.....	30
D. Interlock System.....	31
E. Series System.....	31
3.3.System Configuration and Flow Rate Curve.....	32
3.4.Parameter Settlement.....	34
3.5.Parameter Enquiry and Setting.....	35
3.6.Trial Running.....	38
3.7.Trouble-Shooting.....	40
3.8.Assembly & Parts.....	43
4.Warranty Card.....	50

Notice

- To ensure normal operation of the valve, please consult with professional installation or repairing personnel before use it.
- If there are any of pipeline engineering and electric works, there must be finished by professional at the time of installation.
- Do not use the control valve with the water that is unsafe or unknown quality.
- Depending on the changing of working environment and water requirement, each parameter of softener should be adjusted accordingly.
- When the water treatment capacity is too low, please check the resin. If the reason is shortage of resin, please add; if the resin is turn to reddish brown or broken, please replace.
- Test water periodically to verify that system is performing satisfactorily.
- Ensure that there is solid salt all the time in the brine tank in the course of using, when this valve is used for softening. The brine tank should be added the clean water softening salts only, at least 99.5% pure, forbidding use the small salt.
- Do not put the valve near the hot resource, high humidity, corrosive, intense magnetic field or intense vibrations environment. And do not leave it outside.
- Forbidden to carry the injector body. Avoid to use injector body as support to carry the system.
- Forbidden to use the brine tube or other connectors as support to carry the system.
- Please use this product under the water temperature between 5 ~ 50℃、 water pressure 0.2 ~ 0.6MPa. Failure to use this product under such conditions voids the warranty.
- If the water pressure exceeds 0.6Mpa, a pressure reducing valve must be installed before the water inlet. While, if the water pressure under 0.2 MPa, a booster pump must be installed before the water inlet.
- It is suggested to install PPR pipe, corrugated pipe or UPVC pipe, instead of TTLSG pipe. The pipeline should be straight.
- Do not let children touch or play, because carelessness operating may cause the procedure changed.
- When the attached cables of this product and transformer are changed, they must be changed to the one that is from our factory.
- Please add disc filter in the inlet of the valve.

1.Product Overview

1.1.Main Application & Applicability

Used for softening or demineralization water treatment systems

F78A (Down-flow) suit for the ion exchange equipment which hardness of the raw water $\leq 6.5\text{mmol/L}$

Boiler softening water system

RO pretreatment softening system

F78B(Filter) suit for swimming pool filter equipment

Filtration equipment

RO pretreatment active carbon and sand filtration system

1.2.Product Characteristics

➤Simple structure and reliable sealing

The distribution valve adopts hermetic head faces with high degree pottery and corrosion resistance for opening and closing. The main valve uses the structure of four tee pistons. The distribution valve is combined with main valve.

➤No water pass the valve in regeneration or washing in single tank type.

➤Brine refill is controlled by electric ball valve.

Brine refill is controlled by electric ball valve, refilled when in service, shorten the regeneration time.

➤Variety kinds of installation methods.

The valve is installed on the side of tank, easy to operate.

Inlet, outlet, and drain adopt UPVC pipe by glue, it comes with animated connector.

Inlet can connect pressure gauge. Sampling valve on outlet.

➤Suitable for filtration system

Maximal drain size is the same as water outlet. In case of block brine line connector (To be model F78B), it could be used in filtration system.

➤Manual function

Realize regeneration immediately by pushing  at any time.

➤Long outage indicator

If outage overrides 3 days, the time of day data “12: 12” will flash to remind people to reset new time of day. The other set parameters do not need to reset. The process will continue to work after power on.

➤ **LED dynamic screen display**

The stripe on dynamic screen flash, it indicates the control valve is in service, otherwise, it is in regeneration cycle.

➤ **Button lock**

No operations to buttons on the controller within 1 minute, button lock indicator light on which represent buttons are locked. Before operation press and hold the ▲ and ▼ buttons for 5 seconds to unlock. This function can avoid incorrect operation.

➤ **It can choose time clock type or meter type by program selection**

When all symbols light on, press and hold ⏸ and ⏪ buttons for 5 seconds to enter the menu of valve model selection. Please set the program type in accordance with the product type. (Tim clock type by days or hours or meter type) (Notice: The meter type product has one flow meter and flow meter cable, but the time clock type doesn't have).

➤ **Interlock function**

It has a function of interlock to realize only one valve in regeneration but the other valves are in service while several valves parallel in system. In multi-steps treatment systems such as RO pre-treatment, when several valves are in series, there is only one valve in regeneration or washing to ensure pass water all the times .(Application refer to Figure 3-9)

➤ **Signal output**

There is a signal output connector on main control board. It is for controlling external wiring(Refer to Figure from Figure3-1 to Figure 3-8).

There are two kinds of output modes: b-01 Mode: Turn on start of regeneration and shut off end of regeneration; b-02 Mode: Signal available only intervals of regeneration cycles and In service.

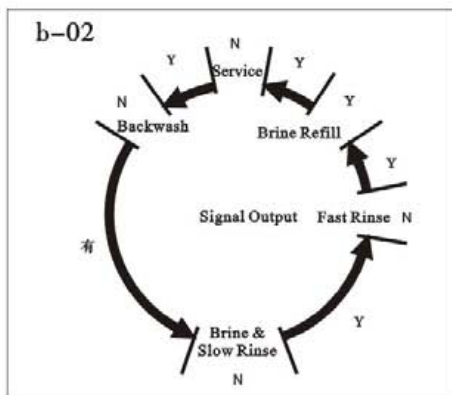
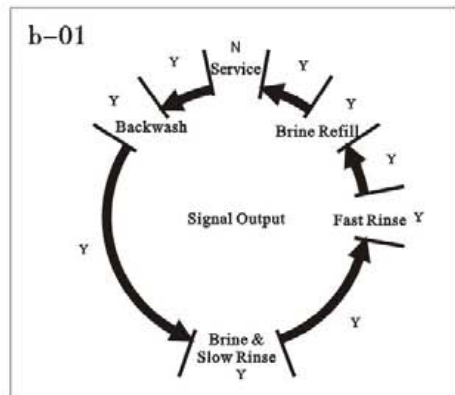

MODEL: 63540-F78A1/63640-F78A3/53530-F78B1

➤ Remote handling input

This connector can receive external signal, used together with PLC, and computer etc. to control the valve. (Application refer to Figure3-11)

➤ Pressure relief output

The signal will open for 20 minutes when exchanging work position. It mainly used to control miniature DC diaphragm water pump or air pump. Let the water pressure or air pressure which between water inlet and distribution valve within valve's working range, to ensure normal working.

➤ All parameters can be modified

According to the water quality and usage, the parameters in the process can be adjusted.

➤ Two meter types for optional (Suit for F78A3)

Mode	Name	Instruction
A-01	Meter Delayed	Regenerate on the day although the available volume of treated water drops to zero(0).Regeneration starts at the regeneration time.
A-02	Meter Immediate	Regenerate immediately when the available volume of treated water drops to zero(0).

➤ Maximum interval regeneration days (Suit for F78A3)

Under the situation of service reaching the setting days and the volume not yet, it could enter into regeneration process forcibly when current time is the same as regeneration time.

➤ Rinsing frequency (Suit for F78B)

It could set up multiple risings, which means several times of backwash and fast rinse but one time of service. It is much better for cleaning the filter materials.

1.3.Service Condition

This valve should be used under the below condition

Item		Requirement
Working conditions	Work pressure	0.2MPa ~ 0.6MPa
	Water temperature	5℃ ~ 50℃
Working environment	Environment temperature	5℃ ~ 50℃
	Relative humidity	≤95% (25℃)
	Electrical facility	AC100 ~ 240V/50 ~ 60Hz
Inlet water quality	Water turbidity	F78A < 2FTU, F78B < 10FTU
	Water hardness	First Grade Na ⁺ < 6.5mmol/L; Second Grade Na ⁺ < 10mmol/L
	Free chlorine	< 0.1mg/L
	Iron ²⁺	< 0.3mg/L
	(CODMn) CODMn	< 2mg/L (O ₂)

In the above table, First Grade Na⁺ represents First Grade Na⁺ Exchanger. Second Grade Na⁺ represents Second Grade Na⁺ Exchanger.

- When the water turbidity exceeds the conditions, a filter should be installed on the inlet of control valve.
- When the water hardness exceeds the conditions, the outlet water hardness will hardly reach the requirement of boiler feed water (0.03 mmol/L) . It is suggested to adopt second grade softener.

MODEL: 63540-F78A1/63640-F78A3/53530-F78B1

1.4.Product Structure and Technical Parameters

A. The appearance is just for reference. It is subjected to the real product.

F78A

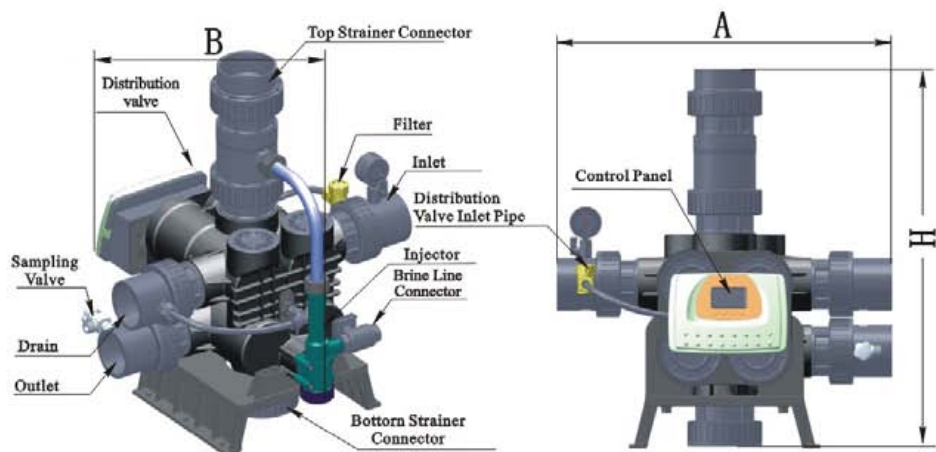

F78B

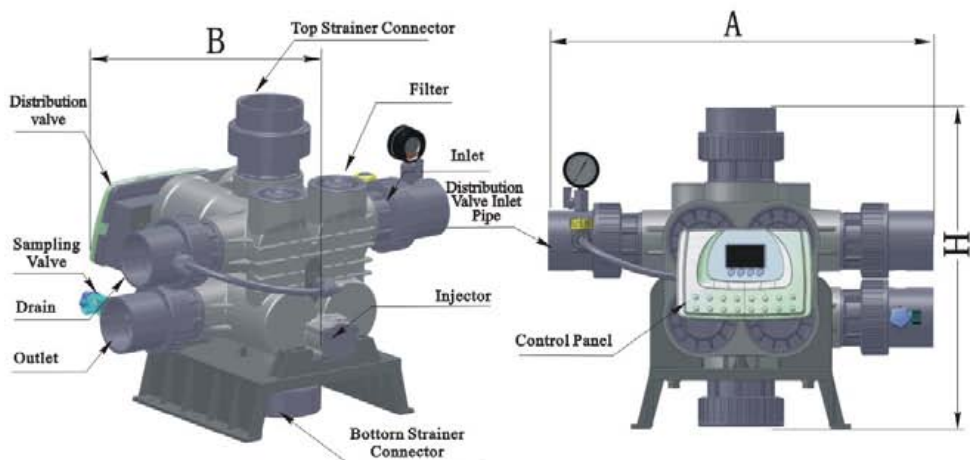

MODEL: 63540-F78A1/63640-F78A3/53530-F78B1

Model	A (mm) max	B (mm) max	H (mm) max
F78A1/63540	561	548	634
F78B1/53540	561	507	468

B. Technical parameter

The suitable output of transformer for control valve: DC12V. 1.5A

Model	Connect Size				FlowRate m ³ /h @0.3MPa	Regeneration Mode	Rem-ark
	Inlet/ Outlet	Drain	BrineLine Connector	Top and Bottom Strainer			
F78A1	DN65	DN65	G3/4	DN80	40	By days	Down- flow regen- eration
F78A2						By hours	
F78A3						Meter type	
F78B1	DN65	DN65	/	DN80	30	By days	Filter
F78B2						By hours	

Note: DN65-Outer diameter is ϕ 75 UPVC pipe.

DN80-Outer diameter is ϕ 90 UPVC pipe.

1.5. Installation

A. Installation notice

Before installation, read all those instructions completely. Then obtain all materials and tools needed for installation.

The installation of product, pipes and circuits, should be accomplished by professional to ensure the product can operate normally.

Perform installation according to the relative pipeline regulations and the specification of Water Inlet, Water Outlet, Drain Outlet, Brine Line Connector.

B. Device location

- ①The filter or softener should be located close to drain.
- ②Ensure the unit is installed in enough space for operating and maintenance.
- ③Brine tank need to be close to softener.

MODEL: 63540-F78A1/63640-F78A3/53530-F78B1

④The unit should be kept away the heater, and not be exposed outdoor. Sunshine or rain will cause the system damage.

⑤Please avoid to install the system in one Acid/Alkaline, Magnetic or strong vibration circumstance, because above factors will cause the system disorder.

⑥Do not install the filter or softener, drain pipeline in circumstance which temperature may drop below 5℃, or above 50℃.

⑦One place is recommended to install the system which cause the minimum loss in case of water leaking.

C. Pipeline installation

①Support installation

Take out the whole fittings and screws, install them according to the figure 1-1. When install support, each number of support should be in correspondence.



Figure 1-1

②Install control valve

a. As the Figure 1-2 shows, insert the riser pipe to the bottom strainer and put it into the bottom of the tank.

b. Fill the mineral to the tank, and the height is accordance with the design code. Install the top strainer

c. Connect the control valve and support with screw.

d. Choose the suitable position to install the valve. Using DN80(Outer diameter is $\phi 90$) UPVC pipe to connect top and bottom strainer connector with tank's top and bottom strainer.



Figure 1-2

Notice:

- Avoid floccules substance together with resin to fill in the mineral tank.
- Piping installation should be straight, and shall not make control valves or the fittings by torsion

③ Install flow meter and the inlet/outlet pipeline

A. Install flow meter

Safe notice:

- A. Before installation, make sure there is no pressure in pipeline and check if pressure released completely.
- B. Before installation, make sure the tested liquid won't make corrosion for the probe. (The testing subject of the probe is water)
- C. Before installation, make sure the temperature and pressure is comply with the probe's requirement.(The temperature of the liquid: 1 ~ 50℃ ; Testing pressure: $\leq 0.6\text{MPa}$)
- D. Before installation, make sure the flow rate of the liquid won't exceed the probe's range. (Testing range: 1 ~ 5m/s) .
- E. Before installation, don't change the probe's shape structure and testing way.
- F. Probe wiring couldn't connect with the transformer which has strong electric or voltage bigger than 12V. Otherwise, it will burn the electric board.

Probe test position choosing:

- A. The measure distance of tangential path behind flange should comply with 10 times front and 5 times back of pipeline diameter.
- B. The measure distance of tangential path behind reducer (Only allow turn big to small, but not in reverse) should comply with 15 times front and 5 times back of pipeline diameter.
- C. The measure distance of tangential path behind first class aqual elbow should comply with 20 times front and 5 time sback of pipeline diameter.
- D. The measure distance of tangential path behind coplanar second class continuous equal elbow should comply with 25 time sfront and 5 times back of pipeline diameter.
- E. The measure distance of tangential path behind non-coplanar second class continuous equal elbow should comply with 40 times front and 5 times back of pipeline diameter.
- F. The measure distance of tangential path behind valve should comply with 50 times front and 5 times back of pipe diameter.
- G. Suggest that install probe perpendicularly by pipeline, shouldn't be installed in the bottom of pipeline.
- H. Probe can be installed in perpendicular pipeline which is upward flow direction, but also shall meet the above line requirement.
- I. Probe can not be installed in perpendicular pipeline which is downward flow direction.
- J. The water in tested pipeline should be full. Make sure no air in the pipeline.

Repair and maintenance of flow meter:

- A. Before the installation of probe need to confirm the impeller in free rotating, there is no obvious block phenomenon.
- B. When the flow meter stop measuring but the tested liquid still flow, it can check the work mode of probe online. Screw the probe nut A out, and check the working condition of the diode on the back of probe. If the diode always light on or off, it indicates the impeller in pipeline stop rotating. It shall stop pipeline working, release pressure in pipeline, and disassemble the probe to check if there is any foreign matter impact impeller rotating. After cleaning, if it can rotate normally by manually, and the diode works normally, it can continue to use after confirming the installation correct.(Refer figure 1-3)
- C. If the probe has impeller broken, the top bracket of probe damaged, bearing bended, after repairing but still unable to free rotation, or the wetted part has corrosion, or the installation screw thread serious damaged, it shall replace a new probe.
- D. If the diode on the back of probe work normally, but the display board show incorrect, please check if the probe wire has any damage and use a multi-meter to check the voltage between shielding and black wire if normally. If the diode light on, there is no voltage output, and if the diode light off, there is voltage output.
- E. As the staining in liquid may cause impeller rotation not smooth, it may affect the measurement accuracy of probe. Therefore, it shall inspect and clean the impeller of probe periodically.

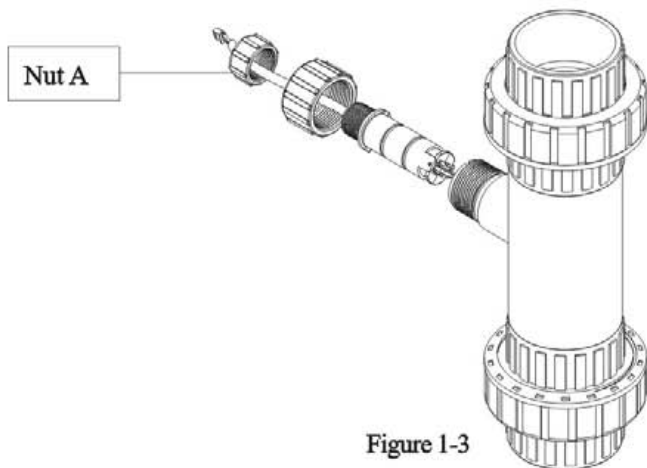

Figure 1-3

- As figure 1-2, install a disc filter on the inlet of the filter.
- Install valve A, valve B and valve C on the inlet, outlet and the middle of the pipeline of inlet and outlet.

MODEL: 63540-F78A1/63640-F78A3/53530-F78B1

c. Glue the inlet of the system with the inlet of the valve with DN65 UPVC pipeline (The outer diameter is $\Phi 75$); Glue the flow meter with outlet of the valve with DN65 UPVC pipeline (The outer diameter is $\Phi 75$); Glue the outlet of the system with flow meter with DN65 UPVC pipeline (The outer diameter is $\Phi 75$).

d. Disassemble the front cover of the valve, connect the flow meter to the flow meter connector of the main control board.(Refer Figure P25 main control board figure)

Notice:

●If making a soldered copper installation, do all sweat soldering before connecting pipes to the valve. Torch heat will damage plastic parts.

●When turning threaded pipe fittings onto plastic fitting, use care not to cross thread or broken valve.

●Inlet pipeline should be in parallel with outlet pipeline. Support inlet and outlet pipeline with fixed holder.

●If the valve belongs to time clock type, there are no flow meter installation step

④Install drain pipeline (If no special request, the injector is 7803)

a. According to P31, for F78A, if the diameter of the tank is 1400mm or 1500mm, please do as step e; if the diameter of the tank is less than 1400mm or longer than 1500mm, please do as following:

b. According to P32, match the drain line flow control based on the number and size of the hole.

c. Use the white manual handle as figure 1-4 shows to open the drain connector, take out the drain line flow control, change it to the suitable one. (Please refer the hole of F32)



Figure 1-4

MODEL: 63540-F78A1/63640-F78A3/53530-F78B1

- d. Tight the drain connector with the drain of the valve.
- e. Use DN65 (Outer diameter is $\phi 75$) UPVC pipeline stick to the drain, drain pipeline should directly to the sewer, the sewer and the drain pipeline should installed as figure 1-5.



Figure 1-5

- f. For F78B filter, there is no drain line flow control, please do as step e.

Notice:

- Leave a certain space between the drain pipe and the sewer, avoid wastewater be absorbing to the water treatment equipment.
- The drain pipeline shouldn't be too long, and the drain should no more higher than the valve. For softener, drain pipeline should no longer than 5m; For filter, it should no longer than 2m. If the drain pipeline is longer or higher than the requirement, please disassemble the connector between distribution valve and drain and let the drain of distribution valve connect with the air. Use G1/2 female screw to block the G1/2 male of drain. Please refer the figure 1-6.



Figure 1-6

⑤Connect brine tube

a. As figure 1-7 shows, use DN20 UPVC pipe and other pipe to connect the brine valve and the brine line connector of the valve.

Notice

●The brine pipeline should as shorter as possible, and smooth. There are less four elbows in the pipeline, or it will make the brine sucking unsmooth.

●It must install brine valve which has air check function in the brine tank.



Figure 1-7

Special instruction

This series of valve need the inlet pressure $\geq 0.2\text{MPa}$, or the piston can't reach the right position which may result in internal mixing water. For RO pretreatment system and second grade Na^+ exchanger, as the pressure drop, the pressure of second and the third one can't reach at 0.2Mpa . There are following solutions:

A. As figure 1-8 shows, install a voltage regulator air pump which has a function of oil removal in the system (The pressure is 0.6Mpa , and the pressure should be bigger than the inlet's), disassemble the connector between the contribution valve and the inlet pipeline, and make the pipeline connect with the air pump, then block the G1/2 female connector on inlet pipeline.

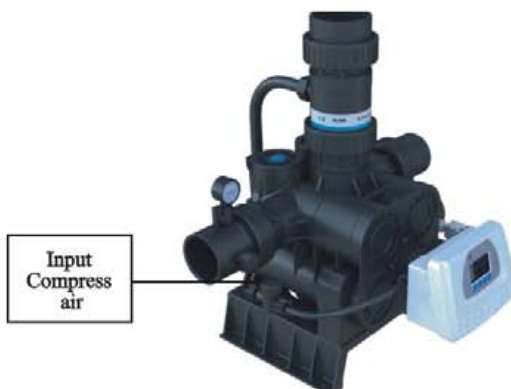

Figure 1-8

MODEL: 63540-F78A1/63640-F78A3/53530-F78B1

B. If the system can't offer a voltage regulator air pump, please refer the figure 1-9, disassemble the connector between the second and the third distribution valve and the inlet pipeline. Use a tee valve to connect the pipelines and make them in parallel with the first control valve's inlet pipeline. Finally block the G1/2 female inlet connector.

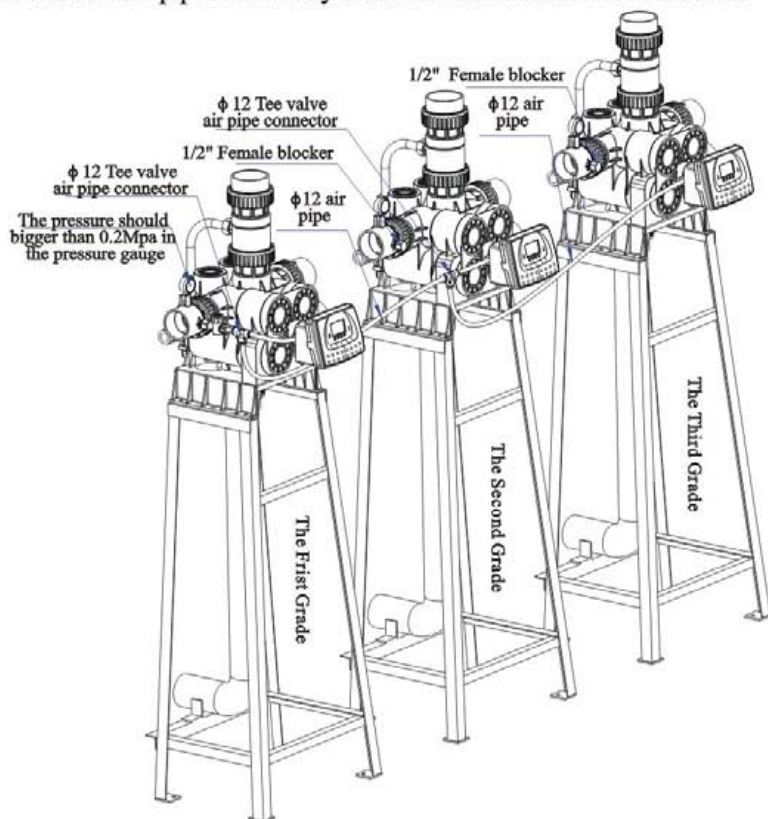
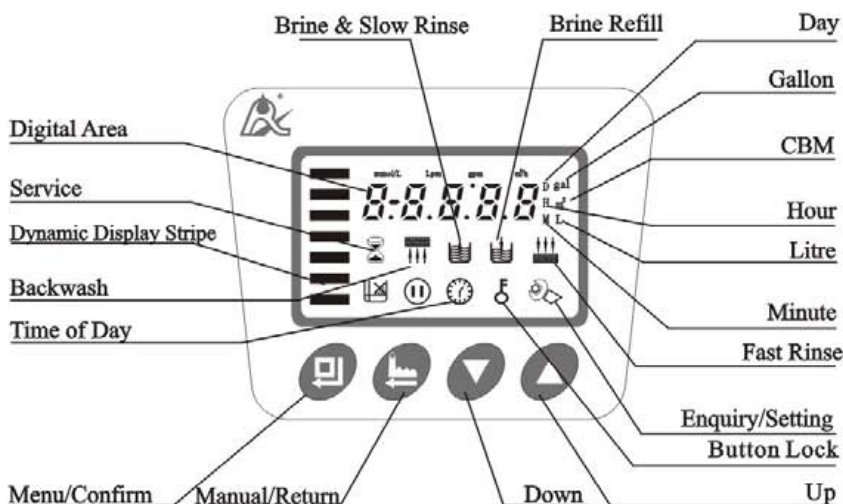

Figure 1-9

C. More than two sets of valve use as one in service one standby or several in service one standby, for using water pump system, the pump head should be more than 30m, the flow rate should be more than (30*set) m³/h. Don't choose low flow rate with high pump head to make sure there is 0.2MPa during working. Then, the system can work normally. If the flow rate can't meet the requirement, please solve the problem according to the instruction A.

2. Basic Setting & Usage

2.1. The Function of PC Board



A. ⌚ Time of day indicator

- ⌚ Light on, display the time of day.

“12: 12” Light flash, remind you to reset the time of day if electrical service interrupted. 3 days more (If electrical service interrupted within 3 days, it doesn't need to reset the time.)

B. ⏹ Button lock indicator

● ⏹ Light on, indicate the buttons are locked. At this moment, press any single button will not work (No operation in one minute, ⏹ will light on and lock the buttons.)

● Solution: Press and hold both ▲ and ▼ for 5 seconds until the ⏹ light off.

C. ⌚ Program mode indicator

● ⌚ Light on, enter program display mode. Use ▲ or ▼ to view all values.

● ⌚ Flash, enter program set mode. Pressor ▲ to ▼ adjust values.

D. ⏹ Manu/Confirm button



● Press ⏹, ⌚ light on, enter program display mode and use ▲ or ▼ to view all values.



● In program display mode, press ⏹, ⌚ flash, enter program set mode, press ▲ or ▼ and adjust values.

MODEL: 63540-F78A1/63640-F78A3/53530-F78B1

● Press  after all program are set, and then the voice “Di” means all setting are success and return program display mode.

E.  Manual/Return button



● Press  in any status, it can proceed to next step.(Example: Press  in Service status, it will start regeneration cycles instantly; Press  while it is in Backwash status, it will end backwash and go to Brine & Slow Rinse at once.)



● Press  in program display mode, and it will return in Service; Press  in program set mode, and it will return program display mode.

● Press  while adjusting the value, then it will return program display mode directly without saving value.

F. Down  and Up 



● In program display mode, press  or  to view all values.

● In program set mode, press  or  to adjust values.





● Press and hold both  and  for 5 seconds to lift the Button Lock status.

2.2. Basic Setting & Usage



A. Parameter specification (For F78A softener)

Function	Indicator	Factory Default	Parameter Set Range	Instruction
Time of Day		Random	00:00 ~ 23:59	Set the time of day when use; “:” flash.
Control Mode	A-01	A-01	A-01	Meter delayed: Regenerate on the day although the available volume of treated water drops to zero (0). Regeneration starts at the regeneration time.
			A-02	Meter immediate: Regenerate immediately when the available volume of treated water drops to zero(0).
Service Days		1-03D	0 ~ 99days	Only for Time Clock Type, regeneration by days
Service Hours		1-20H	0 ~ 99hours	Only for Time Clock Type, regeneration by hours
Regeneration Time	02:00	02:00	00:00 ~ 23:59	Regeneration time; “:” light on



MODEL: 63540-F78A1/63640-F78A3/53530-F78B1

Water Treatment Capacity		400m ³	0 ~ 99.99 m ³	Water treatment capacity in one circle (m ³)
Backwash Time		10min.	0 ~ 99 : 59	Backwash time(Minute)
Brine & Slow Rinse Time		60min.	0 ~ 99 : 59	Brine & Slow rinse time(Minute)
Fast Rinse Time		10min.	0 ~ 99 : 59	Fast rinse time(Minute)
Brine Refill Time		5min.	0 ~ 99 : 59	Brine refill time(Minute)
Maximum Interval Regeneration Days	H-30	30	0~40	Regenerate on the day even through the available volume of treated water do not drop to zero (0).
Output Control Mode	b-01	01	01 or 02	Mode b-01: Signal turn on start of regeneration and shut off end of regeneration. (Connection refer to the Figure P5) Mode b-02: Signal available only intervals of regeneration cycles and in service. (Connection refer to the Figure P5)

B. Parameter specification (For F78B filter)

Function	Indicator	Factory Default	Parameter Set Range	Instruction
Time of Day		Random	00:00 ~ 23:59	Set the time of day when use “: ” flash.
Service Days		1-03D.	0 ~ 99days	Only for Time Clock Type, regeneration by days

MODEL: 63540-F78A1/63640-F78A3/53530-F78B1

Service Hours		1-20H.	0 ~ 99hours	Only for Time Clock Type, regeneration by hours
Rinsing Time		02:00	00:00 ~ 23:59	Rinsing time; “:” light on
Rising Frequency		F-00	0 ~ 20	Rising frequencies. For example, F01: indicate service 1 time, backwash and fast rinse 2 times
Backwash Time		10min.	0 ~ 99 : 59	Backwash time(Minute)
Fast Rinse Time		10min.	0 ~ 99 : 59	Fast rinse time (Minute)
Output Mode		B-01	01 or 02	Mode b-01: Signal turn on start of regeneration and shut off end of regeneration. (Connection refer to the Figure P5) Mode b-02: Signal available only intervals of regeneration cycles and in service. (Connection refer to the Figure P5)

C. Process Display

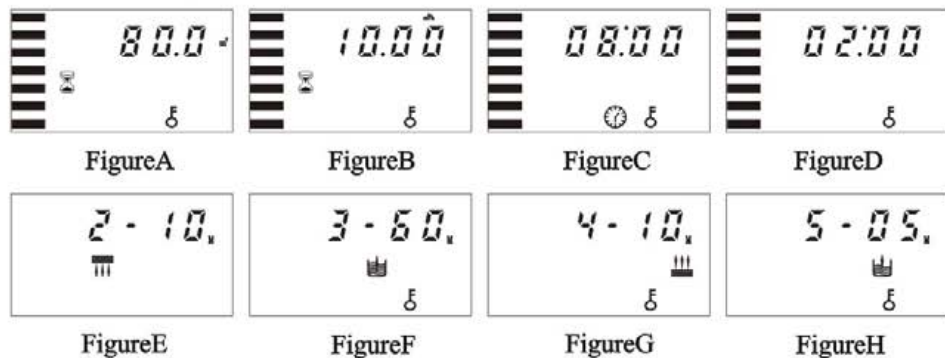

Illustration

● In Service status, the figure shows A/B/C/D; In Backwash status, it shows figure E/C; In Brine & Slow Rinse status, it shows F/C; In Brine Refill status, it shows figure G/C; In Fast Rinse status, it shows figure H/C. In each status, every figure shows 15 seconds.

● Above displays are taking the Meter Type for example. For the Time Clock Type, it shows the rest days or hours, such as 1-03D or 1-10H.

● The display screen will only show “-00-” when the electrical motor is running

● The time of day figure “12: 12” flash continuously, such as “12: 12” flash, indicates long outage of power. It reminds to reset the time of day.

MODEL: 63540-F78A1/63640-F78A3/53530-F78B1

- The display will show the error code, such as “-E1-” when the system is in error.
- Working process: Service → Backwash → Brine & Slow Rinse → Fast Rinse → Brine Refill → Service.













D. Usage

After being accomplished installation, parameter setting and trial running, the valve could be put into use. In order to ensure the quality of outlet water can reach the requirement, the user should complete the below works:













① Ensure that there is solid salt all the time in the brine tank in the course of using when this valve is used for softening. The brine tank should be added the clean water softening salts only, at least 99.5% pure, forbidding use the small salt and iodized salt.

② Test the outlet water and raw water hardness at regular time. When the outlet water hardness is unqualified, please press the  under unlock status and the valve will temporary regenerate again (It will not affect the original set operation cycle.)

③ When the feed water hardness change a lot, you can adjust the water treatment capacity as follow:

Press and hold both  and  for 5 seconds to lift the lock status. Press , and the  light on, then press , the digital area show the control mode. If it shows A-01 or A-02, press  three times, and the digital area will show the given water treatment capacity; Press  again,  and digital flash. Press  or  continuously, reset the capacity value. Press  and hear a sound “Di”, then finish the adjustment. Press  exit and turn back the service status.

The estimation of water treatment capacity, you can refer to the professional application specification.

④ For A-01 control mode (Delayed regeneration type), please pay attention to whether the time is current or not. If the time is not right, you can adjust as follow: After lifting the lock status, press , the  and  light on. Then press , the  and hour value flashes. Press  or  continuously, reset the hour value; Press  again,  and minute value flash. Press  or  continuously, reset the minute value; Press  and hear a sound “Di”, then finish the adjustment. Press  exit and turn back the service status.

The regeneration parameters have been set when control valve left factory. Generally, it does not need to reset. If you want enquiry and modify the setting, you can refer to the professional application specification.

3.Applications

3.1.Softener Flow Chart

Service status

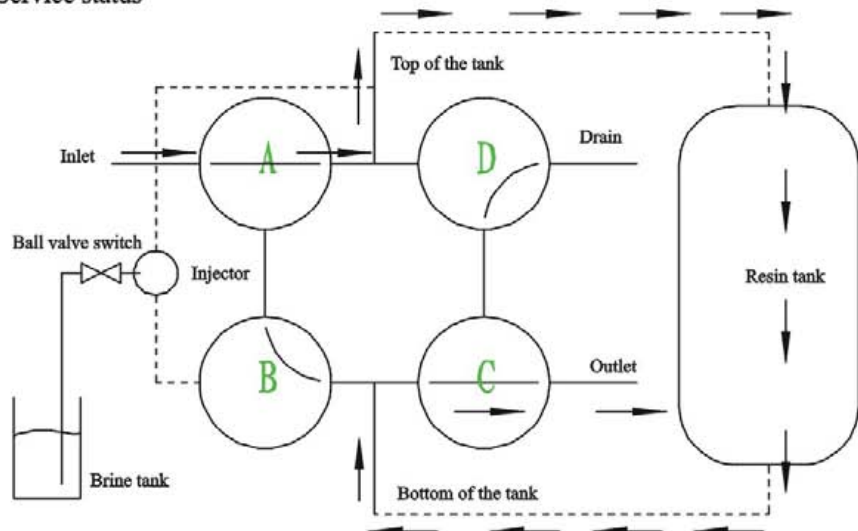

Backwash status

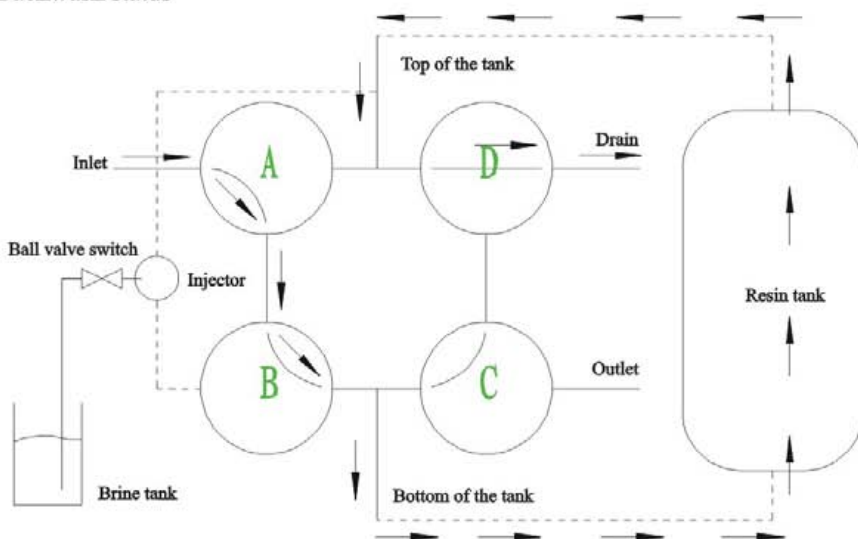

Brine & slow rinse status

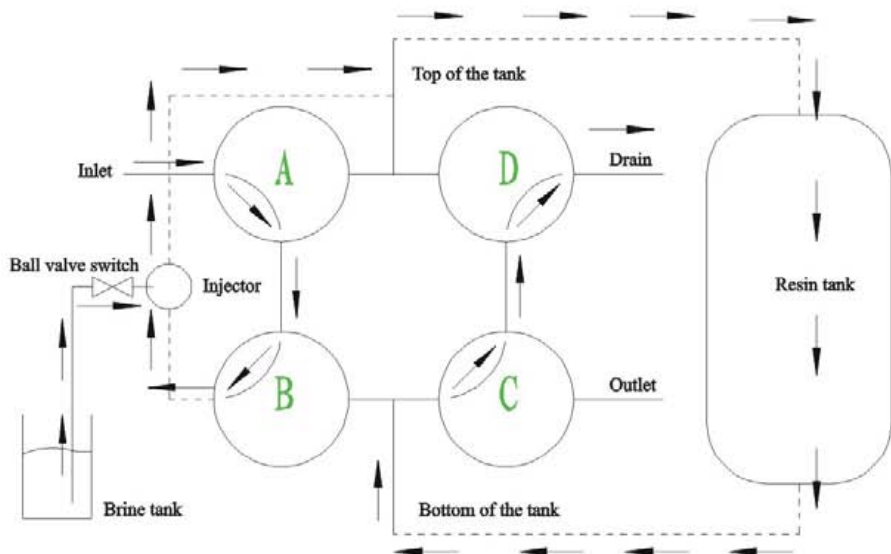

Fast rinse status

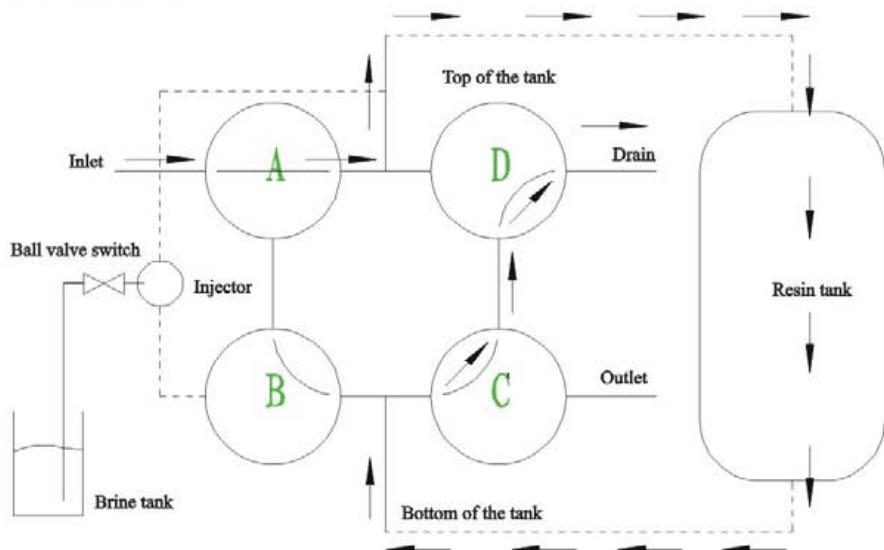

Brine refill state

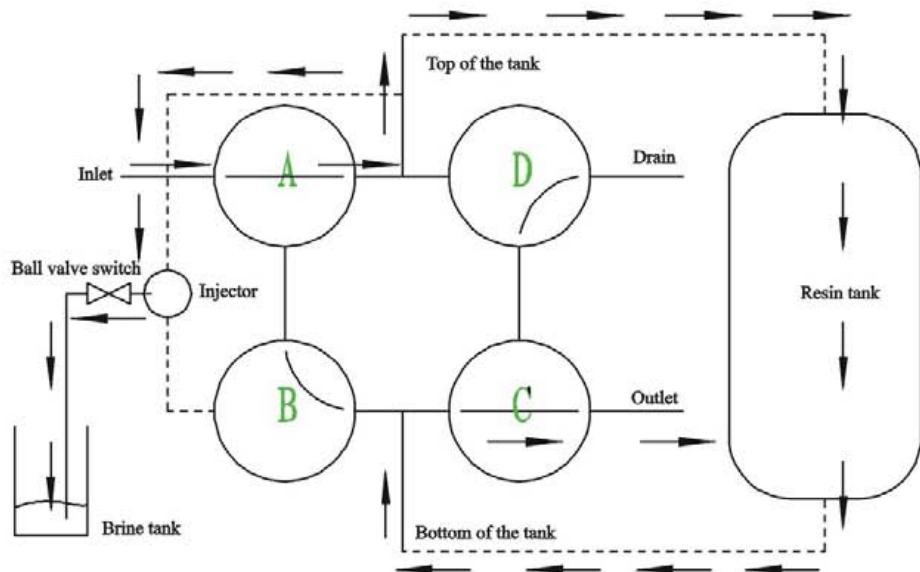

Brine refill and service are in same status, when brine refilling, brine sucking valve open, after finish the brine refilling, the valve is closed.

For F78B filter, only have service status, backwash status and fast rinse status.

3.2.The Function and Connection of PC Board

Open the front cover of control valve, you will see the main control board and connection port as below:

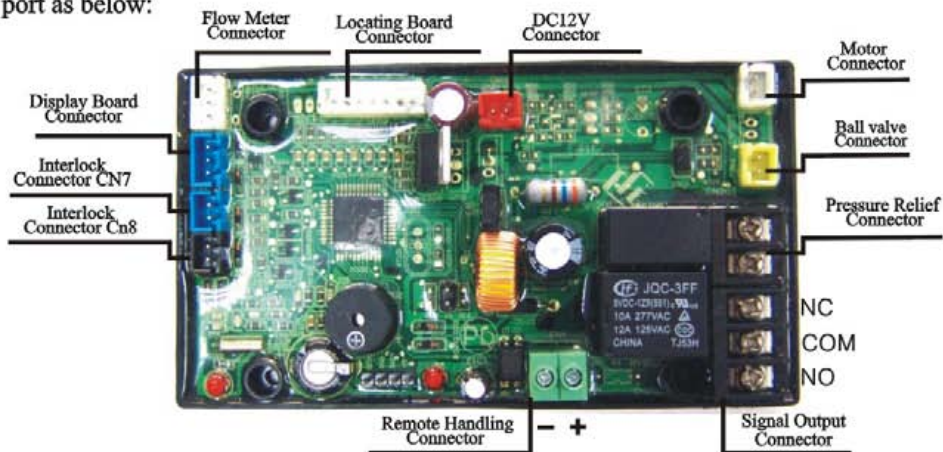

The main functions on main control board:

Function	Application	Explanation
Signal output connector b-01	Outlet solenoid valve	If system strictly require no hard water flow from outlet or controlling the liquid level in water tank.
	Inlet pump	Increase pressure for regeneration or washing. Use the liquid level controller to control inlet pump to ensure there is water in tank.
Signal output connector b-02	Inlet solenoid valve or inlet pump	When inlet pressure is high, it needs to close water inlet when valve is rotating to protect motor.
Pressure relief connector	Control the inlet and distribution valve Connect the air pipe pressure	When the inlet pressure is less than 0.2MPa, and valve is rotating,the connector is opened to increase pressure to the required one.
Interlock connector	To ensure only one control valve regeneration or washing in system.	Use in RO Pre-treatment, water supply together but regeneration in turn. Second grade ion exchange equipment, etc.
Remote handling connector	Receipt signal to make the control rotate to next circle	It is used for on-line inspection system, PC connection, and realize automatically or remote controlling valve.

MODEL: 63540-F78A1/63640-F78A3/53530-F78B1

A. Signal Output Connector

1) Control Solenoid Valve (Set b-01)

① Solenoid valve on outlet controls water level in brine tank. Instruction: If system strictly require no hard water flow from outlet in regeneration cycle(mainly for no hard water flow out when valve is switching or valve in backwash or brine drawing positions), a solenoid valve could be installed on outlet, the wiring refer to Figure 3-1.

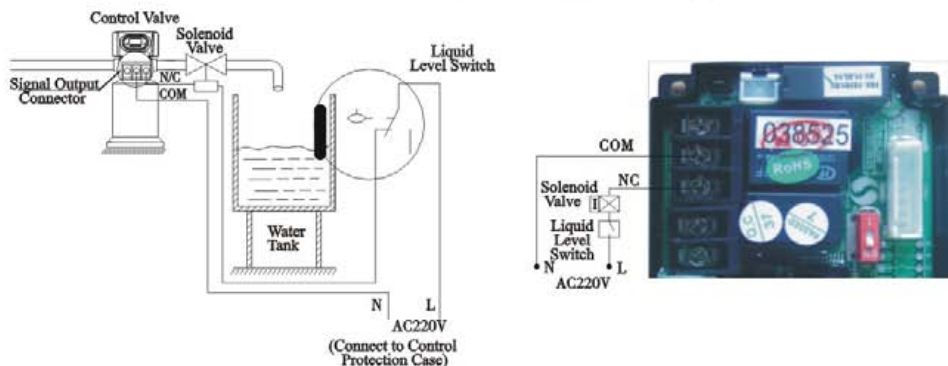

Figure3-1 Wring of Solenoid Valve on Outlet

Function:

When valve in “service” status, if soft water tank is short of water, solenoid valve is open to supply soft water, but if water tank has enough water, solenoid valve us closed, so no soft water supplied.

When the valve in “backwash” status, there is no signal output. So, solenoid valve is closed, to ensure no hard water flow into water tank.

② Solenoid Valve on Inlet (Set b-02)

Instruction: When inlet pressure exceeds 0.6MPa, install a solenoid valve on inlet. Control mode is b-02. Pressure relieved when valve switching, the wiring refer to Figure 3-2. As Figure 3-3 shows, it also can use the pressure relief Connector to work.

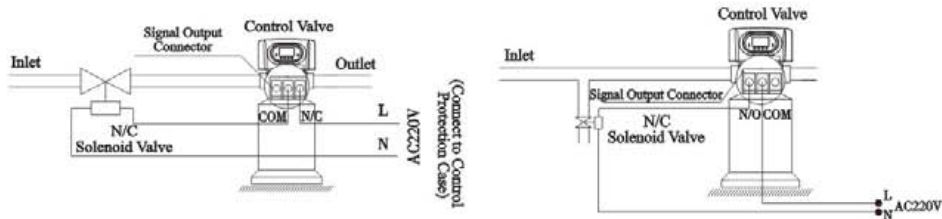

Figure 3-2 Wiring of Solenoid Valve on Inlet Figure 3-3 Wiring of Pressure Relief Connector

MODEL: 63540-F78A1/63640-F78A3/53530-F78B1

Function:

When inlet pressure is high, install a solenoid valve on inlet to ensure valve switching properly. When valve is exactly at position of Service, Backwash, Brine& Slow Rinse, Brine Refill and Fast Rinse, solenoid valve is open. When valve is switching, solenoid valve is closed, no water flow into valve to ensure valve switching properly. It could prevent the problem of mix water and water hammer.

Use interlock cable to realize valves in parallel and series in same system which is suited for RO pretreatment system or second grade Na⁺ system. The Wiring refer to Figure 3-4:

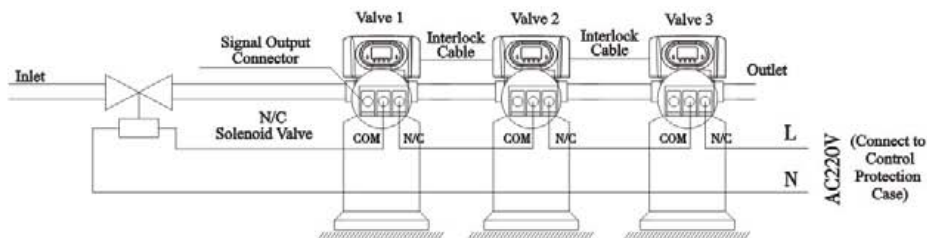
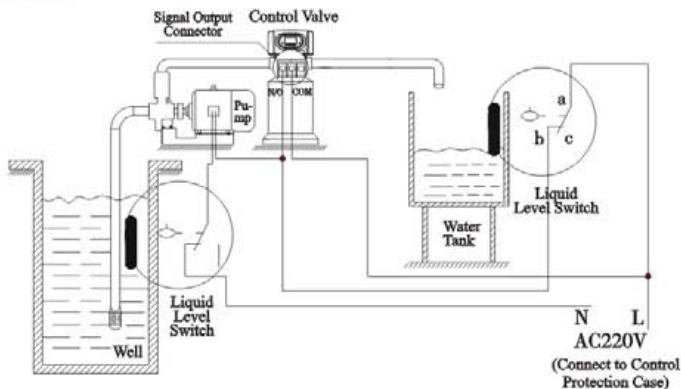

Figure 3-4 Wiring of Solenoid Valve in Inlet

2) Liquid Level Controller Controls Inlet Pump (Two-phase motor)(Set b-01)

Instruction: For the system using well or middle-tank supplying water, which can choose liquid level controller and valve together control pump opening or closing. The wiring refer to Figure 3-5:



Wiring of Liquid Level Controller Controlling Inlet Pump

Function:

When valve in “service” status, if water tank is short of water, start up pump, but if water tank has enough water, the switch of liquid level controller is closed, so pump doesn't work.

MODEL: 63540-F78A1/63640-F78A3/53530-F78B1

When valve in regeneration cycle open the water pump to ensure inlet always has water no matter what is water condition in water tank. As Runxin valve no water pass outlet in regeneration cycle, it ensure no water fill into brine tank.

A liquid switch at the top opening of well or in middle water tank in RO system protect pump from working without water in case of out of raw water.

3) Liquid Level Switch in Water Tank Controls Inlet pump (Three-phase refer Figure3-6) (Set b-01)

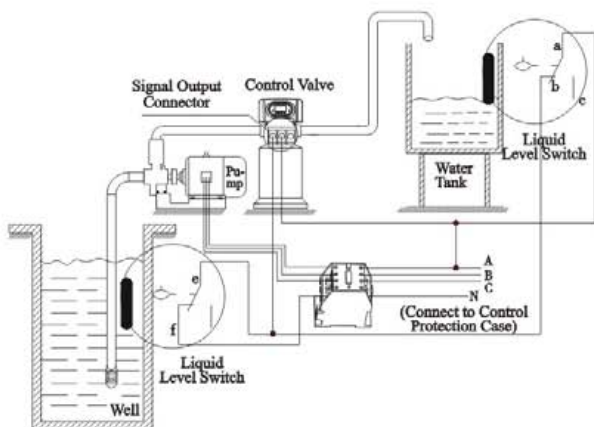

Figure 3-6 Wiring of Liquid Level Switch in Water Tank Controls Inlet Pump

4) Control Inlet Booster Pump(Set b-01 or b-02)

Instruction: If inlet water pressure is less than 0.15MPa, which can't get good backwash effect or makes rinse drawing difficult, a booster pump is suggested to be installed on inlet. Control mode b-01. When system in regeneration cycle, booster pump is open, the wiring refer to Figure 3-7.If the booster pump current is bigger than 5A, system need to install an contactor, the wiring refer to Figure 3-8.

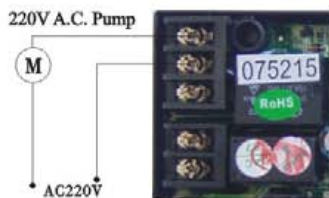

Figure 3-7 Wiring of Booster Pump on Inlet

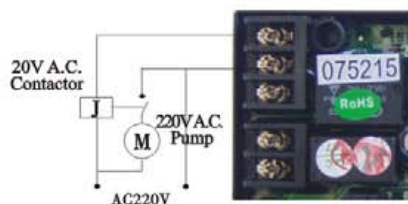

Figure 3-8 Wiring of Booster Pump on Inlet

B. Interlock

Instruction:

In the parallel water treatment system, it ensure only one valve in regeneration or washing cycle and (n-1) valves in service, that is, realizing the function of supplying water simultaneously and regenerating individually

In the series and parallel water treatment system (Second grade Na⁺ Exchanger or RO pre-treatment system), it ensure only one valve in regeneration or washing cycle and there is/are water(s) in service. refer to Figure 3-9

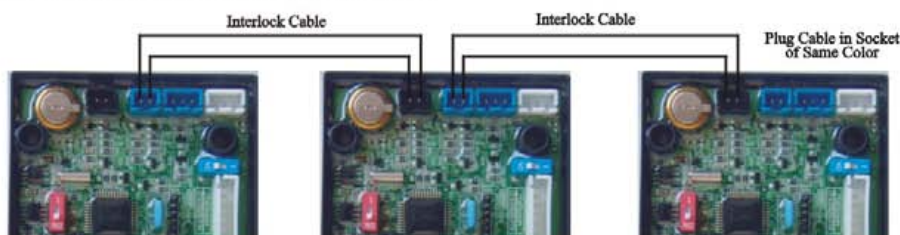

Figure 3-9 Network System Wiring with Interlock Cable

Note: Use Interlock Cable to connect CN8 (black one) to CN7 (blue one) on next valve in the loop.

One system with several valves, if interlock cable is disconnected, the system is divided into two individual system.

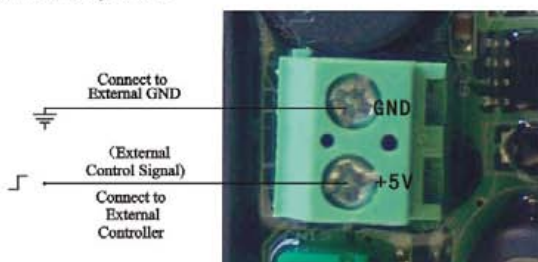

Figure 3-10 Wiring of Remote Input

C. Remote Handling Connector

Used for making pure water, connected with online monitory system or PC machine: when the conduc tivity or other parameter reach the setting valve or PC machine give the signal, need regeneration.It can give the signal to the rem ote handling connector of the main control board to let it regenerate by signal time The connector receives the signal is same as handle press. The wiring refers to Figure 3-10

MODEL: 63540-F78A1/63640-F78A3/53530-F78B1

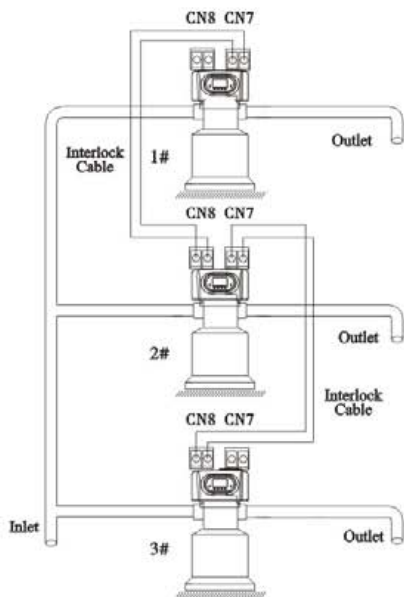

Figure 3-11 Interlock system

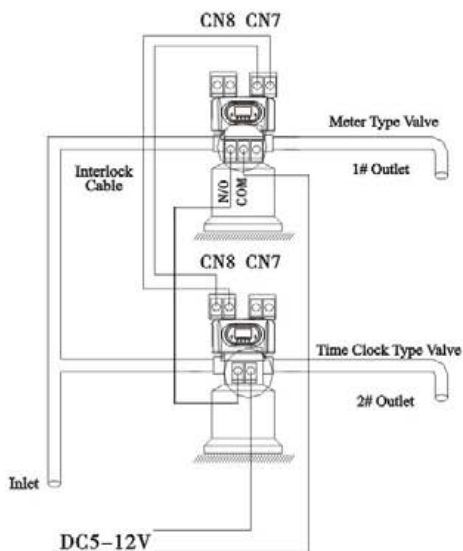

Figure 3-12 Series system

D. Interlock system

2 or more than 2 valves are interlocked connecting in one system and all valves are in service but regenerate individually. The wiring refer to Figure3-11.

E. Series System

This is a 2 or more than 2 valves system, all in service, with one flow meter for the entire system. For the time type valve, the regeneration time should be set and adjusted to the Max; for the volume type valve, connect its signal output connector with the remote handle connector of the time-type valve. That can realize the function of supplying water simultaneously and regenerating orderly. The wiring refer to Figure 3-12

MODEL: 63540-F78A1/63640-F78A3/53530-F78B1

3.3. System Configuration and Flow Rate Curve

A. Product Configuration

① Product F78A configuration with tank, resin volume, brine tank and injector.

Tank Size (mm)	Resin Volume (L)	Flow Rate (t/h)	Brine Tank Size (mm)	The Minimum Salt Consumption for Regeneration (Kg)	Injector Model
φ 1000 × 2400	1100	20.0	φ 1240×1575	165.00	7801
φ 1200 × 2400	1500	28.0	φ 1360×1690	225.00	7802
φ 1500 × 2400	2500	44.0	φ 1360×1690	375.00	7803
φ 1600 × 2400	2800	50.0	φ 1360 × 1690	420.00	7804

Note: The flow rate calculation is based on linear velocity 25m/h; the minimum salt consumption for regeneration calculation is based on salt consumption 150g / L(Resin).

② Product F78B configuration with tank, filter material.

Tank Size	Volume of Filter Material	Carbon Filter		Sand Filter	
		Filtering Flow Rate	Backwash Flow Rate	Filtering Flow Rate	Backwash Flow Rate
MM	L	m ³ /h	m ³ /h	m ³ /h	m ³ /h
φ 900 × 2400	900	7.6	22.9	15.9	34.3
φ 1000 × 2400	1100	9.5	28.2	19.6	42.4
φ 1200 × 2400	1500	13.5	40.7	28.2	61

Attention: the filtering flow rate of carbon filter is calculated based on the 12m/h operation rate; the backwash flow rate is calculated based on the 10L/(m²*s) backwash intensity; the filtering flow rate of sand filter is calculated based on the 25m/h operation rate; the backwash flow rate is calculated based on the 15L/(m²*s) backwash intensity.

MODEL: 63540-F78A1/63640-F78A3/53530-F78B1

B. Flow Rate Characteristic

1) Pressure-flow rate curve(F78A)

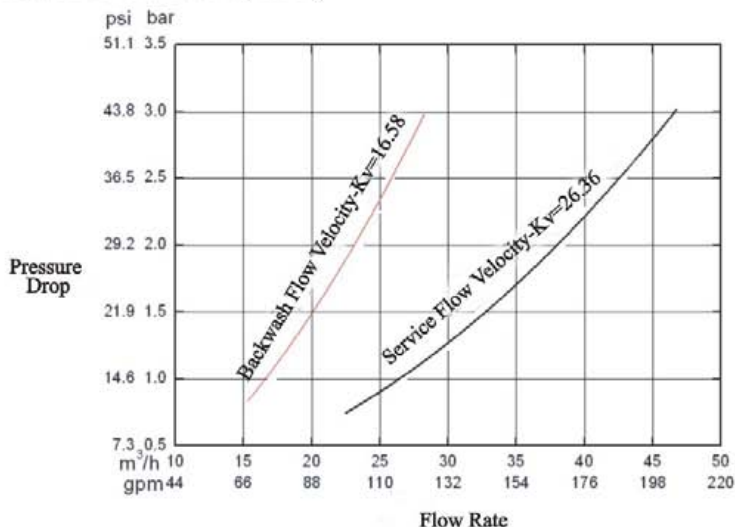

2) Configuration for standard injector and drain line flow control

Tank Dia. Mm	Injector Model	Injector Color	Draw Rate	Slow Rinse Rate	Brine Refill Rate	Hole Qty on Drain Outlet	Hole Size on Drain Outlet	Backwash/ Fast Rinse Rate
			L/h	L/h	L/h		t/h	
1000	7801	Coffee	3960	2550	2150	0	/	12.40
1200	7802	Pink	5280	3430	2150	2	φ 7	17.02
1400	7803	Yellow	6810	4800	3400	4	φ 8	22.34
1600	7804	Blue	7940	5910	3400	5	φ 10	26.83

Note: ①The above data in table is tested under pressure of 0.3MPa.

②Since the different in the quality of raw inlet water, capacity of resin, size of the tank and the pressure of inlet, the above data are only for reference.

③If the real goods are different in specification, configuration or appearance, please subject to the real goods.

④The hole is made depending on the size of matched tank in practical application. The hole's numbers and size are made based on the above table.

⑤The products don't have any special request, the injector is 7803.

3.4. Parameter Settlement

① Service time T1

Water treatment capacity:

$$Q = V_R \times K \div Y_D \quad (\text{m}^3)$$

Hardness of Inlet Water (mmol/L)
 Exchange factor (mmol/L) 400~1000.
 Down-flow regeneration, take 400~750.
 Up-flow regeneration, take 450~1000.
 If the inlet water hardness is higher,
 the factor is smaller.
 Resin volume (m³)

By hour: $T1 = Q \div Q_h$ (Hour)

Water treatment capacity per hour (m³/h)
 Water treatment capacity per day (m³/d)

By day: $T1 = Q \div Q_d$ (day)

Water treatment capacity (m³)
 Water treatment capacity per day (m³/d)

② Backwash time T2 (Only for 17610)

Generally, it is suggested to be set 10~15 minutes. The higher the turbidity is, the longer backwash time can be set. However, if the turbidity is more than 5FTU, it should be better to install a filter in front of the exchanger.

③ Brine & slow rinse time T3

$$T3 = (40 \sim 50) \times H_R \quad (\text{min})$$

$$\text{Generally, } T3 = 45H_R \quad (\text{min})$$

In this formula, H_R The height of resin in exchange tank (m.)

④ Brine refill time T4

$$\text{Down-flow regeneration: } T4 = 0.45 \times V_R \div \text{Brine refill speed}$$

$$\text{Up-flow regeneration: } T4 = 0.34 \times V_R \div \text{Brine refill speed}$$

In this formula, V_R Resin volume (m³)

The Brine refill speed is related to inlet water pressure. It is suggested to lengthen 1~2 minutes of calculated brine refilling time to make sure there is enough water in tank. (The condition is that there is a level controller installed in the brine tank)

⑤ Fast rinse time T5

$$T5 = 12 \times H_R \quad (\text{min.})$$

Generally, the water for fast rinse is 3 ~ 6 times of resin volume. It is suggested to be set 10 ~ 16 minutes, but subject to the outlet water reaching the requirement.

⑥ Exchange factor

Exchange factor = $E/(k \times 1000)$

In this formula, E—Resin working exchange capability (mol/m^3), it is related to the quality of resin. Down-flow regeneration, take 800~900. Up-flow regeneration, take 900~1200.

K—Security factor, always take 1.2~2. it is related to the hardness of inlet water: the higher the hardness is, the bigger the K is.

⑦ Regeneration time

The whole cycle for generation is about two hours. Please try to set up the regeneration time when you don't need water according to the actual situation.

The calculation of parameters for each step is only for reference, the actual proper time will be determined after adjusting by water exchanger supplier. This calculation procedure of softener is only for industrial application; it is not suitable for small softener in residential application.

3.5. Parameter Enquiry and Setting

3.5.1. Parameter Enquiry

When \odot light on, press and hold both \blacktriangle and \blacktriangledown for 5 seconds to lift the button lock statuses; then press \square and \odot light on, enter to program display mode; press \blacktriangle or \blacktriangledown to view each value according to below process. (Press \square exit and turn back to service status)

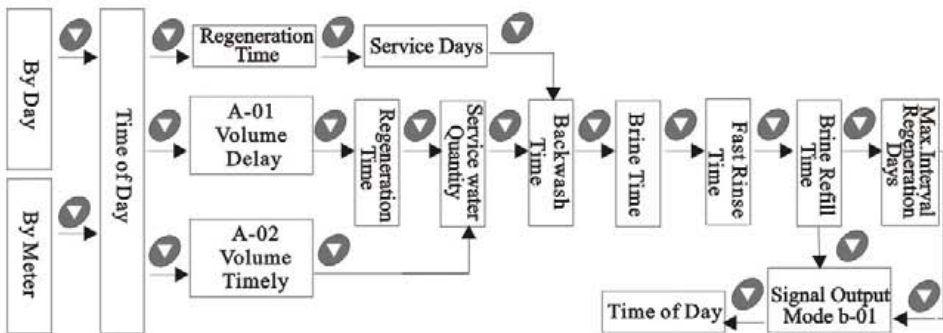







For F78B1, it should add “Resing Frecuence” on the base of F78A1.

3.5.2. Parameter Setting

In program display mode, press \square and enter into program set mode. Press \blacktriangle or \blacktriangledown to adjust the value.

3.5.3. Flow rate factor (K value) check and set



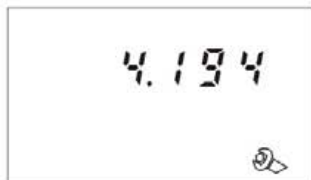









- A. Connect power, all symbols light on, press and hold both  and  for 5 seconds, enter into flow rate factor display and set mode. The value and  both flash, such as showed in right picture.
- B. If need to reset flow rate factor, press  or  to change the value to a needed one, then press  to save the set, and then the voice “Di” means all setting are success and return new service state with updated data.
- C. In flow rate factor display and set mode, if there is no effect operation within 1 minute, the amended data will not be saved, and return service status.





























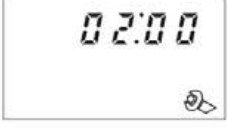















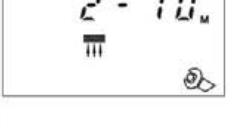





Notice:

- Flow rate factor (K) only exist in F78A3 model.
- The meaning of flow rate factor (K value) is the pulse' s number of probe when each unit liquid volume passing the probe. For example, set the K value to 4.194, it means if there is 1 litre of liquid passing the probe, the probe will have 4.194 pieces of pulse signals. As the tested pipeline diameter is different, user can adjust K value to make adjusting. Each flow meter will have different K values. Flow rate sensor connector is connected with flow meter connector on main control board.

3.5.4. The steps of parameter setting (Take F78A3 as example)

Item	Process step	Symbol
Time of Day	<p>When time of day “12:12” continuously flash, it reminds to reset;</p> <p>1. Press  to enter into program display mode; both  and  symbol light on, “:” flash; Press  enter into time of day setting, both  and hour value flash, through  or  to adjust the hour value;</p> <p>2. Press  again, both  and minute value flash, through  or  to adjust the minute value;</p> <p>3. Press  and hear a sound “Di”, then finish adjustment, press  to turn back.</p>	

MODEL: 63540-F78A1/63640-F78A3/53530-F78B1

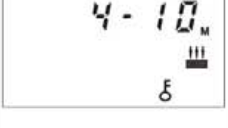
Control Mode	<p>1. In control mode display status, press  and enter into program set mode,  and 01 value flash;</p> <p>2. Press  or , set the value to be A-01 or A-02 control mode</p> <p>3. Press  and hear a sound "Di", then finish adjustment, press  to turn back.</p>	
Regeneration Time	<p>1. In regeneration time display status, press  and enter into program set mode. show "2-00"  And 02 flash;</p> <p>Press  or  to adjust the hour value;</p> <p>2. Press  again,  and 00 flash, press  or  to adjust the minute value;</p> <p>3. Press  and hear a sound "Di", then finish adjustment, press  to turn back.</p>	
Water Treatment Capacity	<p>1. In water treatment capacity display status, it shows  and 10.00. Press  and enter into program set mode.  and 10.00 flash;</p> <p>2. Press  or  to adjust the water treatment capacity value (m³);</p> <p>3. Press  and hear a sound "Di", then finish adjustment, press  to turn back.</p>	
Backwash Time	<p>1. In backwash time display status, it shows  and 2-10.</p> <p>Press  and enter into program set mode.  and 10:00 flash;</p> <p>2. Press  or  to adjust the backwash time (minute);</p> <p>3. Press  and hear a sound "Di", then finish adjustment, press  to turn back.</p>	
Brine & slow Rinse Time	<p>1. In brine & slow rinse time display status, it shows  and 3-60:00. Press  and enter into program set mode.  and 60:00 flash;</p> <p>2. Press  or  to adjust the brine time (minute);</p> <p>3. Press  and hear a sound "Di" then finish adjustment, press  to turn back.</p>	
Fast Rinse Time	<p>1. In fast rinse time display status, it shows  and 5-10:00. Press  and enter into program set mode.  and 5:00 flash;</p> <p>2. Press  or  to adjust the fast rinse time (minute);</p> <p>3. Press  and hear a sound "Di", then finish adjustment, press  to turn back.</p>	

MODEL: 63540-F78A1/63640-F78A3/53530-F78B1











<p>Brine Refill Time</p>	<p>1. In brine refill time display status, it shows and 4-05:00, Press and enter into program set mode. And 05 flash;</p> <p>2. Press or to adjust the brine refill time (minute);</p> <p>3. Press and hear a sound “Di”, then finish adjustment, press to turn back.</p>	
<p>Maximum Interval Regeneration Days</p>	<p>1. In maximum Interval regeneration days display status, it shows H-30. Press and enter into program set mode. And 30 flash;</p> <p>2. Press or to adjust the Interval regeneration days;</p> <p>3. Press and hear a sound “Di”, then finish adjustment, press to turn back.</p>	
<p>Signal Output Mode</p>	<p>1. In signal output mode display status, it shows b-01. Press and enter into program set mode. and 01 flash;</p> <p>2. Press or to adjust the mode (b-02);</p> <p>3. Press and hear a sound “Di”, then finish adjustment, press to turn back.</p>	

For example, the fast rinse time of a softener is 12 minutes. After regenerating, the chloridion in the outlet water is always higher than normal, indicating that there is not enough time for fast rinse. If you want the time to set to 15 minutes, the modification steps as follows:

- ① Press and hold both and to lift the button lock statues (light off) ;
- ② Press , and light on;
- ③ Press or continuously until light on. Then the digital area shows: 4-12M;
- ④ Press , and 12 flash;
- ⑤ Press continuously until 12 changed to 15;
- ⑥ Press , there is a sound “Di” and the figure stop flashing; the program back to enquiry status.
- ⑦ If you want to adjust other parameters, you can repeat the steps from ② to ⑤; If you don't, press and quit from the enquiry status, the display will show the current service status.

3.6. Trial running

After installing the multi-functional flow control valve on the resin tank with the connected pipes, as well as setting up the relevant parameter, please conduct the trial running as follows:

- A. Close the inlet valve B & C, and open the bypass valve A. After cleaning the foreign materials in the pipe, close the bypass valve A. (As Figure 1-3)
- B. Fill the brine tank with the planned amount of water and adjust the air check valve. Then add solid salt to the tank and dissolve the salt as much as possible.
- C. Switch on power. Press  and go in the Backwash status; when  light on, slowly open the inlet valve B to 1/4 position, making the water flow into the resin tank; you can hear the sound of air-out from the drain pipeline. After all air is out of pipeline, then open inlet valve B completely and clean the foreign materials in the resin tank until the outlet water is clean. It will take 8~10 minutes to finish the whole process.
- D. Press  finish back wash, turning the position from Backwash to Brine& Slow Rinse;  light on and enter in the process of Brine& Slow Rinse. The air check valve close when control valve finished sucking brine, then slow rinse start to work. It is about 60~65minutes for whole process.
- E. Press  to Fast rinse status.  light on. It takes about 10~15minutes, take out some outlet water for testing: if the water hardness reach the requirement, and the chloridion in the water is almost the same compared with the inlet water, then go to the next step.
- F. Press  finish fast rinse to Brine refill status.  light on and it indicates the brine tank is being refilled with water to the required level. It takes about 5~6 minutes, then add solid salt to the brine tank.
- G. Press  finish brine refill, making the control valve return to Service Status;  light on and start to running.

Note:

- When the control valve enter into the regeneration status, all program can be finished automatically according to the setting time; if you want one of steps terminated early, you can press .
- If water inflow too fast, the media in tank will be damaged. When water inflow slowly, there is a sound of air emptying from drain pipeline.
- After changing resin, please empty air in the resin according to the above Step C.
- In the process of trial running, please check the water situation in all status, ensuring there are no resin leakage.
- The time for Backwash, Brine& Slow Rinse, Brine Refill and Fast Rinse status can be set and executed according to the calculation in the formula or suggestions from the control valve suppliers.

3.7. Trouble-Shooting

A. Control Valve Fault

Problem	Cause	Correction
1. Softener fails to regenerate.	A. Electrical service to unit has been interrupted. B. Regeneration cycles set incorrect. C. Controller is defective. D. Motor fails to work.	A. Assure permanent electrical service (Check fuse, plug, pull chain or switch). B. Reset regeneration cycles. C. Replace controller. D. Replace motor.
2. Regeneration time is not correct.	A. Time of Day not set correctly. B. Power failure more than 3 days.	Check program and reset time of day.
3. Softener supply hard water.	A. Bypass valve is open or leaking. B. No salt in brine tank. C. Injector plugged. D. Insufficient water flowing into brine tank. E. Leak at O-ring on riser pipe. F. Internal valve leak. G. Regeneration cycles not correct. H. Shortage of resin. I. Bad quality of feed water or turbine blocked.	A. Close or repair bypass valve. B. Add salt to brine tank and maintain salt level above water level. C. Change or clean injector. D. Check brine tank refill time. E. Make sure riser pipe is not cracked. Check o-ring and tube pilot. F. Change valve body. G. Set correct regeneration cycles in the program. H. Add resin to mineral tank and check whether resin leaks. I. Reduce the inlet turbidity, clean or replace turbine.
4. Softener fails to draw brine.	A. Line pressure is too low. B. Brine line is plugged. C. Brine line is leaking. D. Injector is plugged. E. Internal control leak. F. Drain line is plugged. G. Sizes of injector and DLFC not match with tank. H. Ball valve or cable failure	A. Increase line pressure. B. Clean brine line. C. Check brine line. D. Clean or replace injector. E. Replace valve body. F. Clean drain line flow control. G. Select correct injector size and DLFC according to the P20 requirements. H. Replace ball valve or cable.
5. Unit used too much salt.	A. Improper salt setting. B. Excessive water in brine tank.	A. Check salt usage and salt setting. B. See problem No.6.

MODEL: 63540-F78A1/63640-F78A3/53530-F78B1

<p>6.Excessive water in brine tank.</p>	<p>A. Overlong refilling time. B. Excessve water after brine. C. Foreign material in brine valve. D. Not install Liquid level controller but power failure whiling salting. E. Brine refill can't be controlled. F. Ball valve doesn't close</p>	<p>A. Reset correct refilling time. B. Clean brine line and injector. C. Clean brine valve and brine line. D. Stop water supplying and restart after power on or install liquid level controller . E. Repair or replace the liquid level controller . F. Repair or replace ball valve.</p>
<p>7.Pressure lost or iron in conditioned water.</p>	<p>A. Iron in the water supply pipe. B. Iron mass in the softener. C. Fouled resin bed. D. Too much iron in the raw water</p>	<p>A. Clean the water supply pipe. B. Clean valve and add resin cleaning chemical, increase frequency of regeneration. C. Check backwash, brine draw and brine tank refill. Increase frequency of regeneration and backwash time. D. Iron removal equipment is required to install before softening.</p>
<p>8.Loss of mineral through drain line.</p>	<p>A. Air in water system. B. Strainer broken. C. Improperly sized drain line control.</p>	<p>A. Assure that well system has proper air eliminator control. B. Replace new strainer. C. Check for proper drain rate.</p>
<p>9.Control cycle continuously.</p>	<p>A. Locating signal writing breakdown. B. Controller is faulty. C. Foreign material stuck the driving gear. D. Time of regeneration steps were set to zero.</p>	<p>A. Check and connect locating signal wiring. B. Replace controller. C. Take out foreign material. D. Check program setting and reset.</p>
<p>10.Drain flows continuously.</p>	<p>A. Internal valve leak. B. When electricity fails to supply, valve stops backwash or rapid rinseposition. C.Low inlet pressure</p>	<p>A. Check and repair valve body or replace it. B. Adjust valve to service status or turn off bypass valve and restart when electricity supply. C.Increase the inlet pressure to reach the request.</p>
<p>11.Interrupted or irregular brine.</p>	<p>A. Water pressure too low or not stable. B. Injector is plugged or faulty. C. Air in resin tank. D. Floccules in resin tank during up-flow regeneration. E.Strainer blocked</p>	<p>A. Increase water pressure. B. Clean or replace injector. C.Check and find the reason. D. Clean the floccules in resin tank. E.Remove the broken resin.</p>
<p>12.Water flow out from drain or brine pipe after regeneration.</p>	<p>A. Foreign material in valve which makes valve can't be closed completely. B. Hard water mixed in valve body. C. Water pressure is too high which result in valve doesn't get the right position. D. Ball valve can' t close</p>	<p>A. Clean foreign material in valve body. B. Change valve core or sealing ring. C. Reduce water pressure or use pressure release function. D. Replace ball valve or cable.</p>

MODEL 63540-F78A1/63640-F78A3/53530-F78B1

13. Salt water in softener water.	A. Foreign material in injector or injector fails to work. B. Brine valve cannot be shut-off. C. Time of fast rinse is too short.	A. Clean and repair injector. B. Repair brine valve and clean it. C. Extend fast rinse time.
14. Water treatment capacity.	A. Regenerate not properly. B. Fouled resin bed. C. Salt setting not proper. D. Softener setting not proper. E. Raw water quality deterioration. F. Turbine of flow meter is stuck.	A. Regenerate according to the correct operation requirement. B. Increase backwash flow rate and time, clean or change resin. C. Readjust brine drawing time. D. According to the test of outlet water, recount and reset. E. Regenerate unit by manual temporary then reset regeneration cycle. F. Disassemble flow meter and clean it or replace a new turbine.

B. Controller Fault

Problem	Cause	Correction
1. All indicators display on display board.	A. Wiring of display board and control board fails to work. B. Control board is faulty. C. Transformer damaged. D. Electrical service not stable.	A. Check and replace the wiring. B. Replace control board. C. Check and replace transformer. D. Check and adjust electrical service.
2. No display on display board.	A. Wiring of display board and control board fails to work. B. Display board damaged. C. Control board damaged. D. Electricity is interrupted.	A. Check and replace wiring. B. Replace display board. C. Replace control board. D. Check electricity.
3. E1 Flashes	A. Wiring of locating board with controller fails to work. B. Locating board damaged. C. Mechanical driven failure. D. Faulty control board. E. Wiring of motor with controller is fault. F. Motor damaged.	A. Replace wiring. B. Replace locating board. C. Check and repair mechanical part. D. Replace control board. E. Replace wiring. F. Replace motor.
4. E2 Flashes	A. Hall component on locating board damaged. B. Wiring of locating board with controller fails to work. C. Control board is faulty.	A. Replace locating board. B. Replace wiring. C. Replace control board.
5. E3 or E4 Flashes	A. Control board is faulty.	A. Replace control board.

3.8.Assembly & Parts

F78A3 Structure (Main body part)

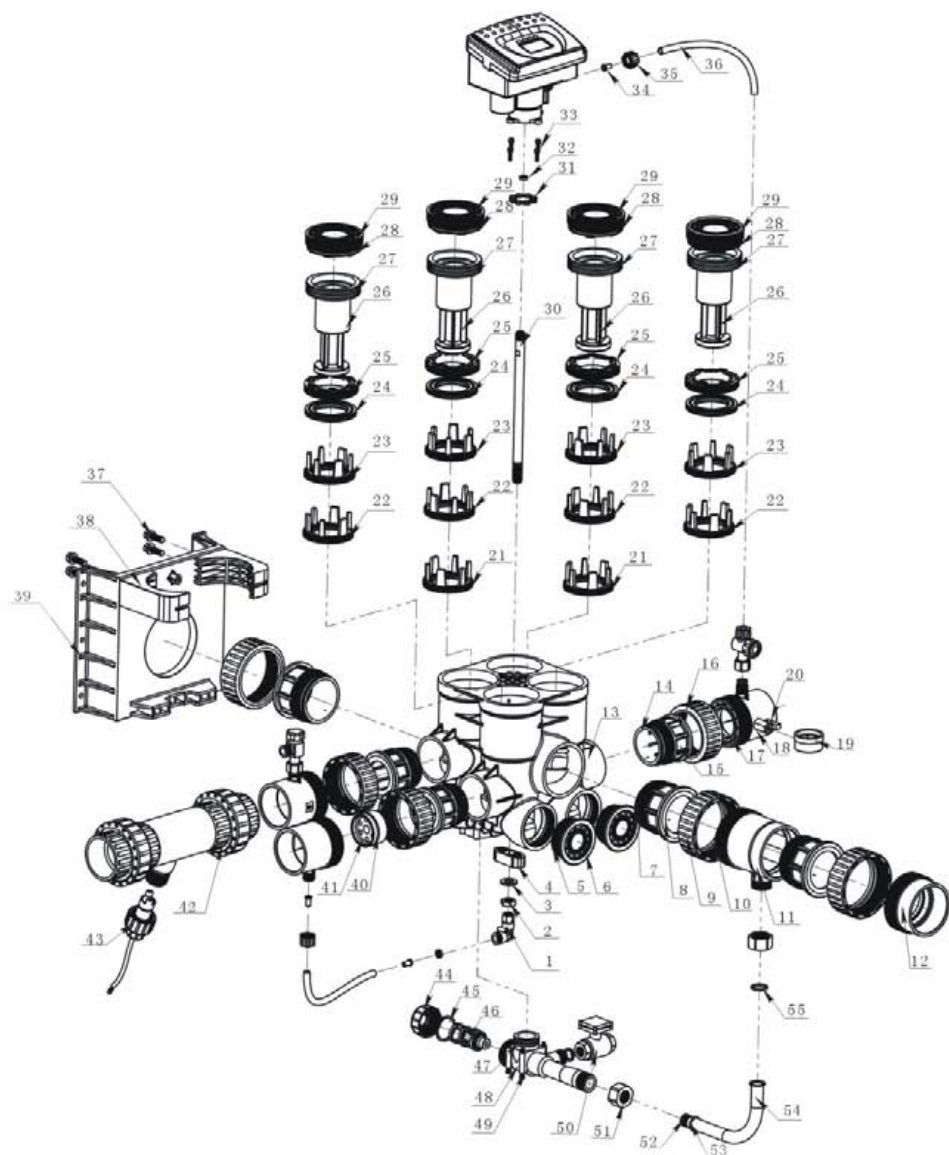

MODEL: 63540-F78A1/63640-F78A3/53530-F78B1

F78A3 Valve Body Components and part No.

Item Number	Description	Part Number	Quantity	Item Number	Description	Part Number	Quantity
1	Air Pipeline Connector	5455001	1	29	Plug	8323010	4
2	Seal Washer	8371011	1	30	Pipeline	8457008	1
3	Hexagonal Nut	8940016	1	31	Seal Washer	8371009	8
4	Washer	8156003	1	32	Seal Washer	8371011	1
5	O-ring	8378127	2	33	Hexagonal Bolt	8920006	4
6	Plug	8323011	2	34	Pipeline	8457025	2
7	O-ring	8378129	3	35	Hexagonal Nut	8940016	2
8	Connector	8458022	3	36	Air Pipeline	8465001	1
9	Animated Nut	8947008	3	37	Hexagonal Bolt	8920001	4
10	O-ring	8378138	3	38	Washer	5156001	2
11	Connector	8458023	1	39	Toggle	8109009	1
12	Connector	8458024	2	40	O-ring	8378125	1
13	Valve Body	5022027	1	41	Flow Control	8468013	1
14	O-ring	8338127	3	42	Tee Joint	5457009	1
15	Connector	8458020	3	43	Impeller Set	5295004	1
16	Animated Nut	8947007	3	44	Injector Cover	5315013	1
17	O-ring	8378137	3	45	Seal Washer	8371006	1
18	Connector	8458021	3	46	Nozzle	8454024	1
19	Pressure Gauge Protect Valve	2976013	1	47	O-ring	8378101	2
20	Pressure Gauge	6342001	1	48	Injector Body	8008006	1
21	Chamber Set	5330001	1	49	Hexagonal Bolt	8920005	4
22	Chamber Set	5330002	4	50	3/4" Electronic Ball Valve	2976008	1
23	Chamber Set	5330003	4	51	O-ring	8378073	1
24	Chamber Set	5330004	4	52	O-ring	8378064	1
25	Fitting Nut	8092010	4	53	Hexagonal nut	8940006	2
26	Piston	8450002	4	54	Elbow Pipeline	8457019	1
27	O-ring	8378139	8	55	Seal Washer	8371010	1
28	O-ring	8378139	8				

MODEL: 63540-F78A1/63640-F78A3/53530-F78B1

F78A3 Structure (Distribution valve part)

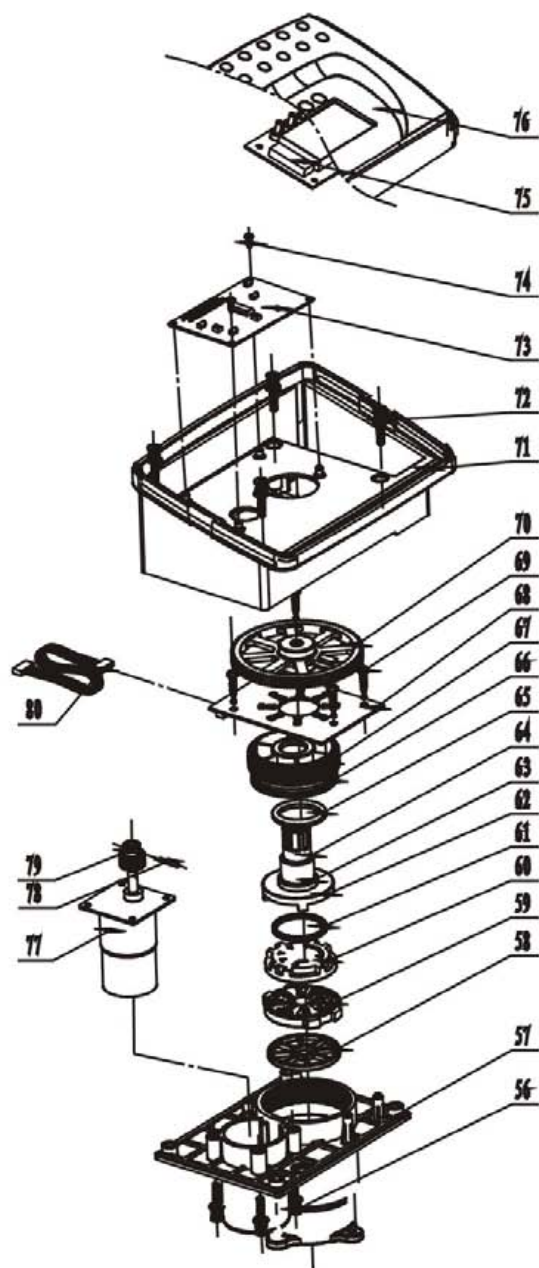

MODEL: 63540-F78A1/63640-F78A3/53530-F78B1

F78A3 Distribution valve components and part No.

Item Number	Description	Part Number	Item Number
56	Screw, Cross (Three parts)	8902008	4
57	Distribution Valve Body	5022028	1
58	Seal Ring	8371031	1
59	Fixed Disk	8469023	1
60	Moving Disk	8459025	1
61	Moving Seal Ring	8370053	1
62	Shaft	8258009	1
63	O-ring	8378078	1
64	O-ring	8378073	1
65	Anti-friction Washer	8216010	1
66	O-ring	8378107	1
67	Fitting Nut	8092007	1
68	Locating Board	6380018	1
69	Screw, Cross	8909007	4
70	Gear	5241005	1
71	Front cover	8005012	1
72	Screw, Cross (Three parts)	8902008	4
73	Control Board	6382033	1
74	Screw, Cross	8909004	2
75	Display Board	6381009	1
76	Front Cover	8300014	1
77	Motor	6158007	1
78	Pin	8993001	1
79	Small Gear	8241010	1
80	Wire for Locating Board	6511002	1

Note:

- 1、The distribution valve for F78A and F78B are the same.
- 2、The difference of control valve between F78B and F78A is: F78B don't have item 40~46、48、50~55, but have No. 8323012 plug.

4. Warranty Card

Dear client:

This warranty card is the guarantee proof of RUNXIN brand multi-functional flow control valve. It is kept by client self. You could get the after-sales services from the supplier which is appointed by RUNXIN manufacturer. Please keep it properly. It couldn't be retrieved if lost. It couldn't be repaired free of charge under the below conditions:

1. Guarantee period expired.(One year);
2. Damage resulting from using, maintenance, and keeping that are not in accordance with the instruction;
3. Damage resulting from repairing not by the appointed maintenance personnel;
4. Content in guarantee proof is unconfirmed with the label on the real good or be altered;
5. Damage resulting from force majeure.

Product Name		Multi-functional Flow Control Valve for Water Treatment Systems		
Model		Code of Valve Body		
Purchase Company Name		Tel/Cel.		
Problem				
Solution				
Date of Repairing		Date of Accomplishment		Maintenance Man Signature

When product need warranty service, please fill in the below content and sent this card together with the product to the appointed suppliers or Runxin company.

End-user Company Name		Tel/Cel.		
Purchase Company Name		Tel/Cel.		
Model		Code of Valve Body		
Tank Size ϕ ×		Resin Tank Size L	Raw Water Hardness	mmol/L
Water Source: Ground-water <input type="checkbox"/> Tap Water <input type="checkbox"/>		Water Treatment Capacity	Backwash Time	min
Brine & Slow Rinse Time min		Brine Refill Time min	Fast Rinse Time	min
Problem Description				



WENZHOU RUNXIN MANUFACTURING MACHINE CO.,LTD

ADD: Jinger Road, Shatou Group, Linjiang, Lucheng District, Wenzhou, Zhejiang, China

TEL: 0577-88635628 88576511

FAX: 0577-88633258

Http://www.run-xin.com

Email:sales@run-xin.com